



Intelligent **X**ansion Series

IX3212 PDM Reference Manual

Warranty - A limited warranty on materials and workmanship is given with this Murphy product.
A copy of the warranty may be viewed or printed by going to www.enovationcontrols.com/warranty



Please read the following information before installing.

BEFORE BEGINNING USE OF THIS PRODUCT:

Read and follow all instructions.

Please contact Enovation Controls immediately if you have any questions.

CONTENTS

1	INTRODUCTION	3
1.1	OVERVIEW	3
1.2	DESCRIPTION	5
1.3	NOTATION CONVENTIONS USED IN THE MANUAL	6
2	INSTALLATION	7
2.1	MOUNTING ORIENTATION	7
2.2	DIMENSIONS	8
2.3	CIRCUIT PROTECTION	9
2.4	RECOMMENDED WIRING PRACTICES	9
3	ELECTRICAL CONNECTIONS.....	11
3.1	CONNECTORS J1 AND J2	11
3.2	CONNECTOR J3	12
3.3	CONNECTOR J4	13
3.4	CONNECTOR J5	14
3.5	CONNECTOR J6	15
4	COMMUNICATION.....	16
4.1	OVERVIEW	16
4.1.1	<i>Source Address</i>	16
4.1.2	<i>Loss of Communication</i>	16
4.1.3	<i>Output Modes</i>	17
4.1.4	<i>Special Methods of Operation</i>	17
4.1.4.1	Power on Reset (POR).....	17
4.1.4.2	Local Source Control	17
4.2	NAMING AND NUMBERING CONVENTIONS	18
4.3	CONFIGURING.....	20
4.3.1	<i>Configure Output Function</i>	21
4.3.1.1	Configuration Identifier	22
4.3.1.2	Output Channel.....	22
4.3.1.3	Soft-Start Step Size	22
4.3.1.4	Motor/Lamp Mode	24
4.3.1.5	Loss of Communication.....	25
4.3.1.6	POR Command	26
4.3.1.7	POR Enable	27
4.3.1.8	Command Type.....	27
4.3.1.9	Motor Braking.....	28
4.3.1.10	LSC Digital Input	28
4.3.1.11	Calibration Time	28
4.3.1.12	Response.....	29
4.3.2	<i>Configure Output Channels</i>	30
4.3.2.1	Output Channel Group Identifier	31
4.3.2.2	Current Limit	31
4.3.2.3	Feedback Type	32
4.3.2.4	Automatic Reset	32
4.3.2.5	High-Side or H-Bridge	33
4.4	COMMANDING	34
4.4.1	<i>Command Output Channels</i>	35
4.4.1.1	Output Command Identifier	36
4.4.1.2	Command	36
4.4.1.3	Enable	37

4.4.1.4	Module Transmit Rate	37
4.5	FEEDBACK AND DIAGNOSTICS.....	38
4.5.1	<i>Analog Inputs 1-2, Digital Feedback</i>	39
4.5.1.1	Feedback and Diagnostics Identifier	40
4.5.1.2	Digital Inputs.....	40
4.5.1.3	Analog Inputs.....	41
4.5.2	<i>Analog Inputs 3-4, Output Diagnostics</i>	42
4.5.2.1	Output Diagnostic	43
4.5.3	<i>Analog Inputs 5-6, Battery and Sensor Supply</i>	44
4.5.3.1	Sensor Supply Low	45
4.5.3.2	Sensor Supply High	45
4.5.3.3	Battery Voltage	45
4.5.4	<i>Analog Inputs 7-8, Software Version and Power Supply</i>	46
4.5.4.1	Total Current Status.....	47
4.5.4.2	Power Supply Status	47
4.5.4.3	Software Version	47
4.5.5	<i>Output Feedback</i>	48
4.5.5.1	Current, Power, Position or Rate Feedback	49
4.5.6	<i>Output Function Handshake</i>	50
4.5.7	<i>Output Configuration Handshake</i>	51
4.6	EXAMPLE MESSAGES.....	53
4.6.1	<i>Arbitration Field</i>	53
4.7	EXAMPLE PSEUDO CODE.....	54
4.7.1	<i>Configure and Verify Outputs</i>	54
4.7.2	<i>Command Outputs</i>	54
4.7.3	<i>Read Diagnostics</i>	54
5	TROUBLESHOOTING	55
5.1	OUTPUT DOES NOT RESPOND.....	55
5.2	PDM DOES NOT FUNCTION	55
6	SPECIFICATIONS.....	56
7	CONDENSED MESSAGE DEFINITION	58

1 Introduction

1.1 Overview

Murphy's Intelligent Xpansion™ Power Distribution Module (PDM) expands CAN bus networks and replaces existing fuse and relay boxes with more reliable, solid-state switches that can directly drive lights, cooling fans, wiper motors and directional DC motors.

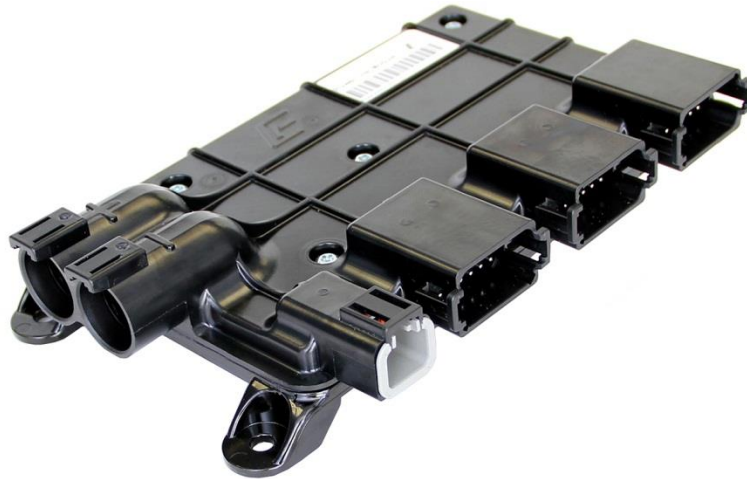

Each of the 12 PDM outputs can switch or proportionally drive 15A loads and feature built-in over-current detection and shutdown capability. Outputs can be paired to run up to six electric motors with H-bridge direction control.

Twelve digital inputs monitor switched battery, ground and floating inputs. Additionally, eight analog inputs are available with a 5V sensor supply.

Wiring length is reduced and costs are cut by remotely locating the PDM module near signals and loads. Then the I/O is multiplexed using a CAN bus network, which allows engineers to greatly simplify harness design for ease of installation and improved reliability.

For applications not requiring a CAN bus, the inputs can directly trigger outputs so there is no need for a separate microcontroller.

The enclosure is fully sealed and potted to withstand wash-down and dust.

The unit is compact and can be mounted nearly anywhere on a vehicle.

The PDM is an advanced CAN-based I/O module with built-in fault detection for directly driving high current loads such as work lights, DC motors and actuators, wiper motors and many other loads. It allows for the flexible I/O extension of CAN bus systems using the SAE J1939 protocol or stand-alone operation replacing traditional switch-activated fuse and relay boxes.

The PDM features a compact, composite polymer aluminum housing and can operate in either 12V or 24V systems. The solid construction and compact enclosure facilitate mounting anywhere on the vehicle.

The PDM provides a novel alternative to current relay/fuse-based solutions. The PDM is potted and has no mechanical parts. It eliminates relays and fuses on the outputs so outputs can be switched ON/OFF or driven proportionally. Output status can be monitored for improved diagnostics, while analog and digital input devices are easily connected and their signals accessed via CAN messages.

The PDM is fully sealed and uses field-proven Deutsch connectors for superior performance in the most adverse environments. In addition, the 12 fully protected solid-state outputs have the capacity to handle high current loads.

The compact housing design simplifies mounting in tight areas and eases harness installation through reduced wiring. An innovative I/O structure that can be monitored and configured remotely allows for quick adaptation in numerous mobile applications.

This robust unit is intended for use in conditions where reliable operation is crucial, extreme temperature variations are common, high shock and vibration levels exist and electromagnetic interference (EMI) is normal.

The PDM is designed for mobile equipment use and is configurable using the SAE J1939 Group A Proprietary message construct.

1.2 Description

The IX3212 PDM is a robust, compact, fully encapsulated unit and is designed for off-highway mobile equipment and other industrial applications.

It features 12 tri-state digital inputs, eight analog inputs and 12 high-current (15 A) high-side outputs. The unit also features a fully protected 5V sensor supply capable of driving 70 mA.

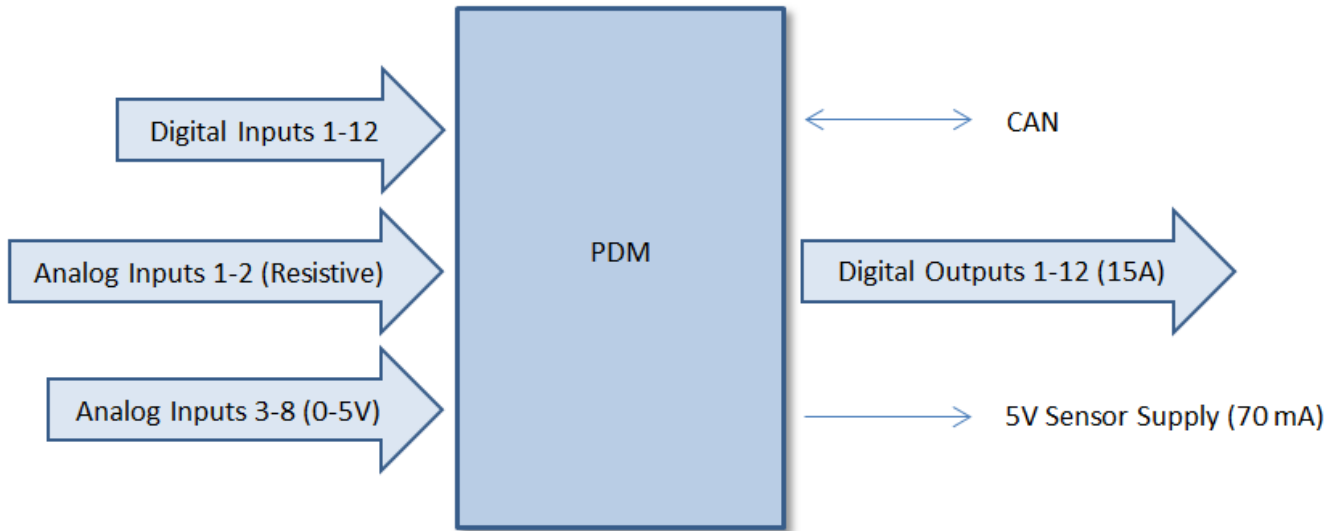

The 12 high-current outputs can be configured as H-Bridge pairs. The outputs also can be configured for pulse-width-modulated (PWM) operation. Outputs 1 to 6 feature a 500 Hz PWM frequency with better than 1 percent duty cycle resolution; these can be used to proportionally drive outputs. Outputs 7 to 12 offer 100 Hz PWM frequency with 10 percent duty cycle resolution. These outputs are best suited for applications where it is acceptable for output levels to increase in incremental steps or with a defined ramp rate.

Each output channel incorporates output-overload-shutdown configurable in 2.5A increments, diagnostic indication of short circuit, overload (based on shutdown value) and open circuit. An indication is given when the entire module has total current overload. The regulated 5-volt output is monitored and two bits indicate diagnostic status for an overload, short circuit or short-to-supply.

The PDM uses CAN messages to receive configuration and control messages as well as send feedback and diagnostics using J1939 Proprietary Group A constructs.

1.3 Notation Conventions Used in the Manual

This document features Adobe Reader bookmarks to quickly jump between sections. Additionally, [blue-colored hyperlinks](#) are used throughout the manual to allow easy navigation between the various CAN messages.

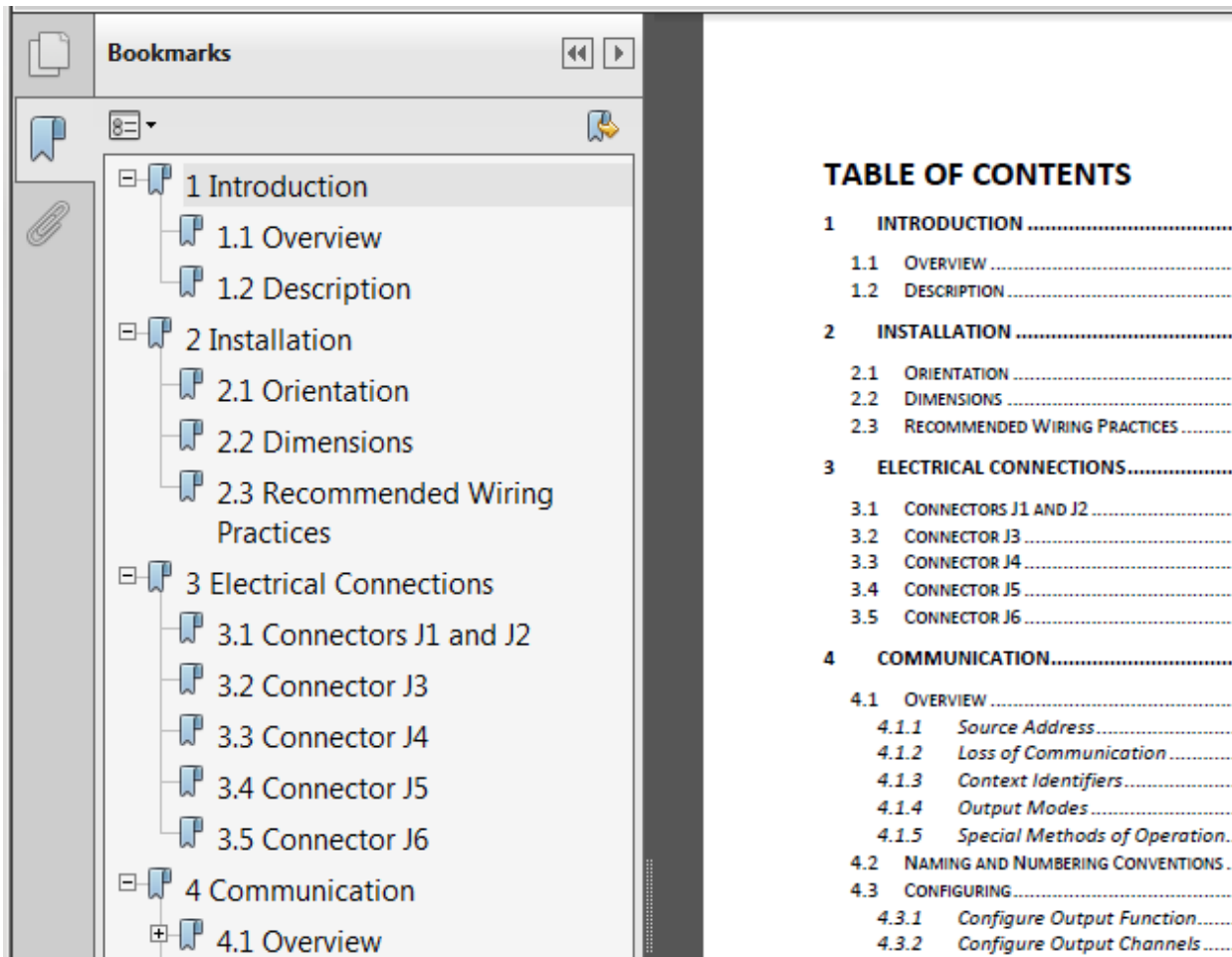

The image shows a screenshot of the Adobe Reader interface. On the left is the 'Bookmarks' panel, which displays a hierarchical tree of document sections. The sections are: 1 Introduction (expanded), 1.1 Overview, 1.2 Description, 2 Installation (expanded), 2.1 Orientation, 2.2 Dimensions, 2.3 Recommended Wiring Practices, 3 Electrical Connections (expanded), 3.1 Connectors J1 and J2, 3.2 Connector J3, 3.3 Connector J4, 3.4 Connector J5, 3.5 Connector J6, 4 Communication (expanded), and 4.1 Overview. On the right is the 'TABLE OF CONTENTS' page, which lists the same sections with their corresponding page numbers and dotted lines indicating the page range for each section.

1	INTRODUCTION
1.1	OVERVIEW
1.2	DESCRIPTION
2	INSTALLATION
2.1	ORIENTATION
2.2	DIMENSIONS
2.3	RECOMMENDED WIRING PRACTICES
3	ELECTRICAL CONNECTIONS.....
3.1	CONNECTORS J1 AND J2
3.2	CONNECTOR J3
3.3	CONNECTOR J4.....
3.4	CONNECTOR J5
3.5	CONNECTOR J6
4	COMMUNICATION.....
4.1	OVERVIEW
4.1.1	Source Address.....
4.1.2	Loss of Communication.....
4.1.3	Context Identifiers.....
4.1.4	Output Modes
4.1.5	Special Methods of Operation...
4.2	NAMING AND NUMBERING CONVENTIONS ..
4.3	CONFIGURING.....
4.3.1	Configure Output Function.....
4.3.2	Configure Output Channels

2 Installation

2.1 Mounting Orientation

The PDM should be mounted on a vertical surface with either J3 – J6 facing down or to the right. Secure the module with either 6 mm or 1/4 in. diameter fasteners.

IMPORTANT: The harness should have a drip loop(s) to allow water to run off the wires.

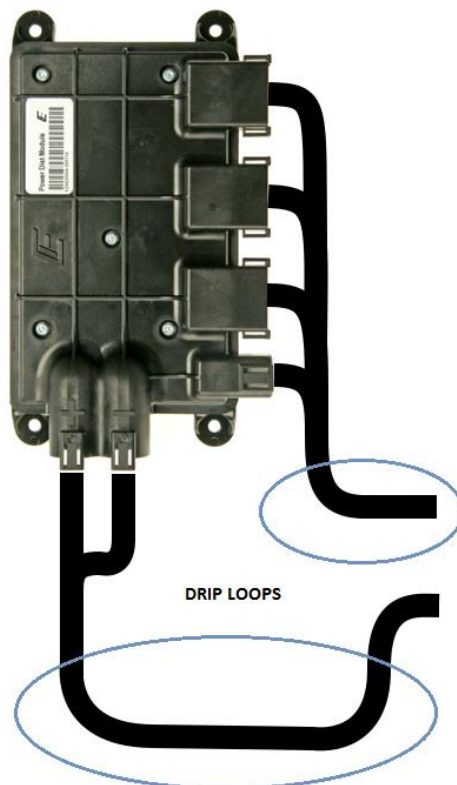
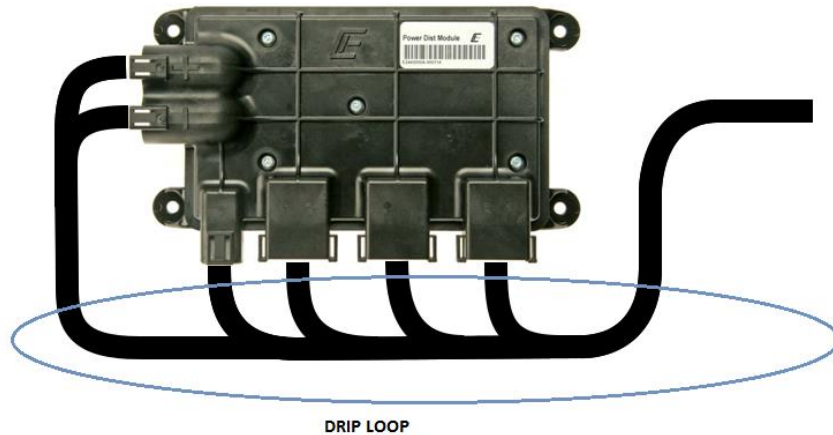

IX3212 PDM shown in preferred mounting orientations

2.2 Dimensions

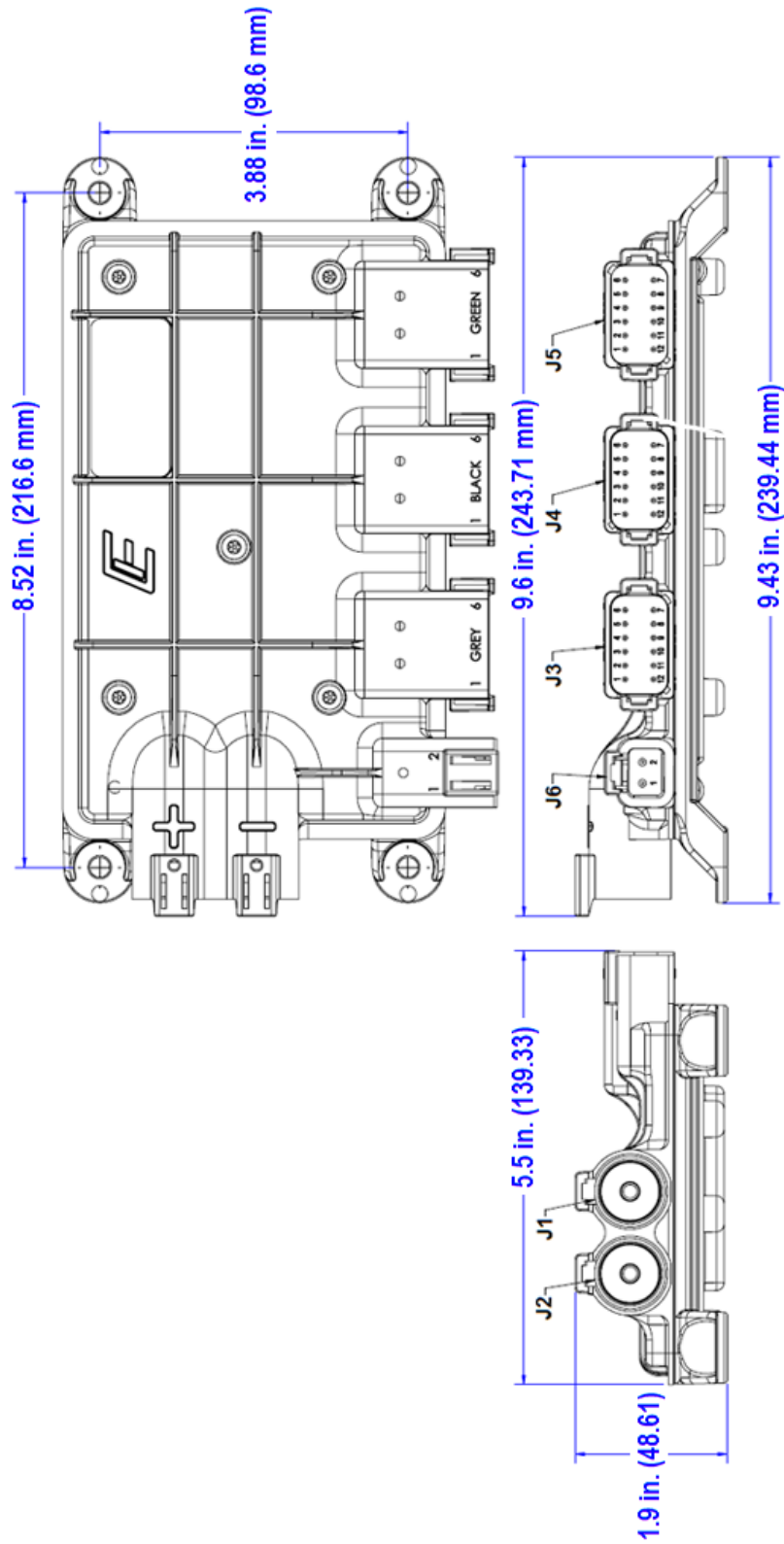

IX3212 PDM Dimensions

2.3 Circuit Protection

A fuse or circuit break on the positive power input (connector J2) is required and should be located near the power source (e.g. battery).



The outputs are monitored for over-current conditions and turn-off in the event of the fault. For information on how to configure the output current limit, refer to Section 4.3.2 – Configure Output Channels.

2.4 Recommended Wiring Practices

This section contains information about the IX3212 connectors and pin outs. Please use the following recommended wiring practices when installing and using the PDM:

- Ensure correct and adequate single point ground to prevent ground loops.
- Use twisted or twisted shielded pair cable for the CAN bus per the applicable standard.
- Ensure the appropriate sized conductor is specified for the intended load current in the harness design for the particular application.
 - SAE J1614 specifies requirements and design guidelines for electrical wiring systems of less than 50 V and cable diameters from 0.35 mm² to 19 mm² used on off-road, self-propelled earthmoving machines as defined in SAE J1116 and agricultural tractors as defined in ASAE S390.
 - SAE J2202 recommends and describes the application of the primary wiring distribution system of less than 50 V and includes wire sizes 0.5 mm² to 19 mm² on heavy-duty on-highway trucks.
 - SAE J1128, ISO 6722 and JASO D608-92 automotive wiring standards aid in determining the recommended conductor sizing table for the respective 12V or 24V system that is powering the load.
 - ABA specifies a marine wiring standard that differs from SAE J1128.
- Wire gauges should be capable of handling at least 135 percent of the circuit's current protection rating.
 - Determine the maximum load the wire is expected to carry, the location of wiring (e.g. in a cab or engine compartment) and ambient temperature).
 - Determine the length of the wire needed to extend from the power source to the load. Include the ground wire length if used.

- Insure that the voltage drop at the load is kept within the recommended 10 percent maximum level for the respective 12V or 24V power system.
- Wire gauge reductions are permissible after the point at which circuit protection is added or enabled.
- Wires should be specified with suitable insulation type for the environment. For instance, GXL (general purpose, cross-linked polyethylene insulated) wire with a medium insulation thickness has a rating of +135°C (+275°F) where the compartment temperatures can exceed +80°C (+176°F) such as the engine compartment.

NOTE: Review the individual over-current shutdown values in the configuration and use the correct wire gauge conductor to accommodate maximum load current configured.

- Use a protective fuse or circuit breaker on the positive input power lead (J2) that is sized appropriately for the PDM supply steady-state load current. Typical maximum load current is 60 percent - 80 percent of the fuse rating not to exceed 70 A.
- Verify that the harness is constructed to meet the needs of the application environment (e.g. shock, vibration, moisture, temperature, chemicals and impact).
- Make certain that the harness is designed and constructed to minimize induced interference resulting from EMI coupling between signal wires.
- Separate power circuits from low-level signals.
- Make provisions for drip loops to attach devices in exposed locations and prevent moisture entry and formation within the connectors.
- Provide sufficient clearance from moving parts.
- Wires routed through holes in the vehicle body/chassis should use grommets.
- Avoid sharp metal edges, fasteners and other abrasive surfaces or use protective shielding when routing harness assembly.
- Route wires to avoid exhaust system components or other high temperature areas. Use appropriate heat shielding or other insulation where routing is a problem.
- Avoid routing near wheel wells or provide adequate mechanical protection (e.g. convoluted conduit) to the wire assembly.

CABLE CONVERSION CHART – METRIC vs. ENGLISH LOW-TENSION PRIMARY CABLE – SAE J1128				
Metric	English		Metric	English
0.5 mm ²	20 Ga		5.0 mm ²	10 Ga
0.8 mm ²	18 Ga		8.0 mm ²	8 Ga
1.0 mm ²	16 Ga		13.0 mm ²	6 Ga
2.0 mm ²	14 Ga		19.0 mm ²	4 Ga
3.0 mm ²	12 Ga			

3 Electrical Connections

3.1 Connectors J1 and J2

The connector pinout is as viewed looking into the PDM receptacles or from the wire side of the mating plugs.

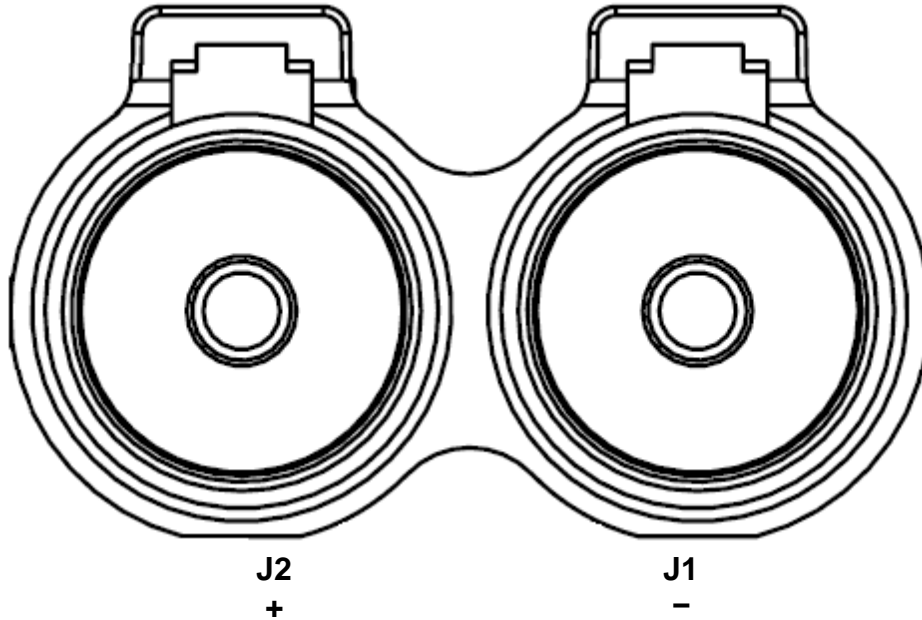

PIN	FUNCTION	LIMIT	Mating Connector
J1	Ground	70 A continuous (return)	DTHD 06-1-4S
J2	V_{BATT}	70 A continuous (source)	DTHD 06-1-4S

IMPORTANT: A circuit breaker or fuse is required on the connection leading to J2 and should be located near the battery or power source.

3.2 Connector J3

The connector pinout is as viewed looking into the PDM receptacles or from the wire side of the mating plugs.

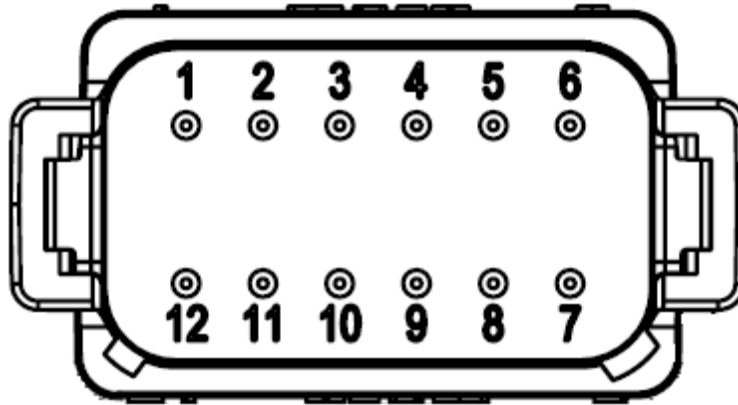

J3

Pin	Function	Limit	Mating Connector
J3-1	5V Regulated Output GND (Isolated)	5 V @ 70 mA (both pins)	DT06-12SA (Gray)
J3-2	Digital Input 12	0-28 VDC	
J3-3	Digital Output 7	15 A (PWM @ 100 Hz)	
J3-4	Digital Output 8	15 A (PWM @ 100 Hz)	
J3-5	Digital Output 9	15 A (PWM @ 100 Hz)	
J3-6	Digital Output 10	15 A (PWM @ 100 Hz)	
J3-7	Analog Input 8	0 – 5 V	
J3-8	Analog Input 7	0 – 5 V	
J3-9	Analog Input 6	0 – 5 V	
J3-10	Analog Input 5	0 – 5 V	
J3-11	Analog Input 4	0 – 5 V	
J3-12	5V Regulated Output (+)	5 V @ 70 mA (Both pins)	

3.3 Connector J4

The connector pinout is as viewed looking into the PDM receptacles or from the wire side of the mating plugs.

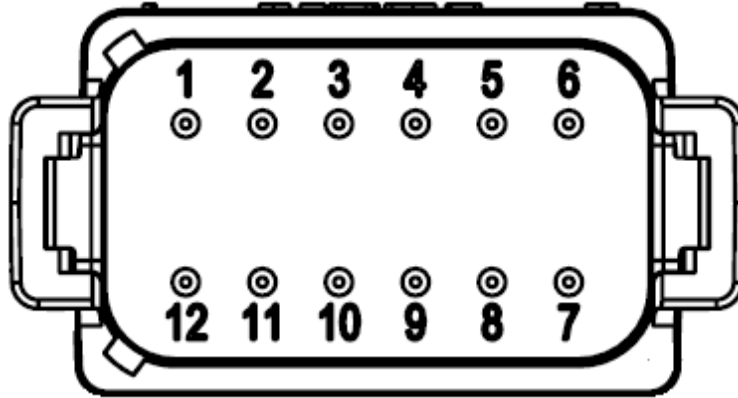

J4

Pin	Function	Limit	Mating Connector
J4-1	Digital Output 1	15 A (PWM @ 500 Hz)	DT06-12SB (Black)
J4-2	Digital Output 2	15 A (PWM @ 500 Hz)	
J4-3	Digital Output 3	15 A (PWM @ 500 Hz)	
J4-4	Digital Output 4	15 A (PWM @ 500 Hz)	
J4-5	Digital Output 5	15 A (PWM @ 500 Hz)	
J4-6	Digital Output 6	15 A (PWM @ 500 Hz)	
J4-7	Analog Input 3	0 – 5 V	
J4-8	Analog Input 2	Resistive	
J4-9	Analog Input 1	Resistive	
J4-10	Digital Input 11	0 – 28 VDC	
J4-11	Digital Input 2	0 – 28 VDC	
J4-12	Digital Input 1	0 – 28 VDC	

NOTE: Digital Inputs 1 and 2 are used to set the Source Address.

3.4 Connector J5

The connector pinout is as viewed looking into the PDM receptacles or from the wire side of the mating plugs.

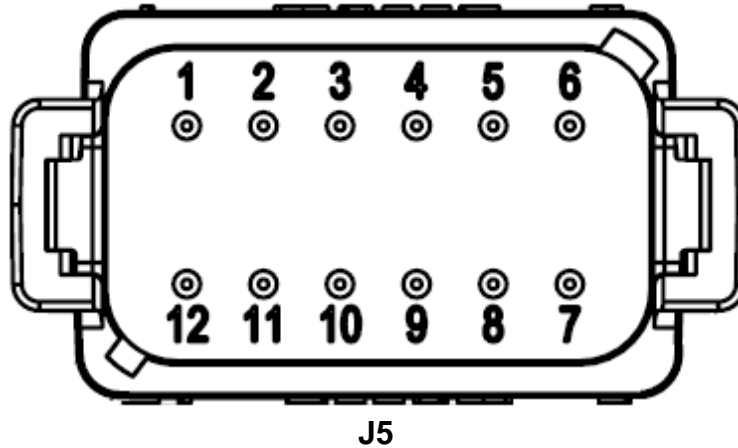

PIN	FUNCTION	LIMIT	Mating Connector
J5-1	CAN LOW	-	DT06-12SC (Green)
J5-2	Digital Input 3	0 – 28 VDC	
J5-3	Digital Input 4	0 – 28 VDC	
J5-4	Digital Input 5	0 – 28 VDC	
J5-5	Digital Input 6	0 – 28 VDC	
J5-6	Regulated Output GND (Isolated)	5 V @ 70 mA (both pins)	
J5-7	Regulated Output (+)	5 V @ 70 mA (both pins)	
J5-8	Digital Input 7	0 – 28 VDC	
J5-9	Digital Input 8	0 – 28 VDC	
J5-10	Digital Input 9	0 – 28 VDC	
J5-11	Digital Input 10	0 – 28 VDC	
J5-12	CAN HIGH	-	

NOTE: The CAN bus circuit has an auto-termination detection circuit built-in that is disabled by default.

3.5 Connector J6

The connector pinout is as viewed looking into the PDM receptacles or from the wire side of the mating plugs.

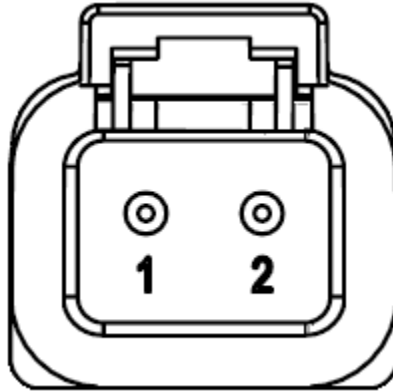

J6

PIN	FUNCTION	LIMIT	Mating Connector
J6-1	Digital Output 12	15 A (PWM @ 100 Hz)	DTP06-2S
J6-2	Digital Output 11	15 A (PWM @ 100 Hz)	

NOTE: Deutsch DT series contacts are size 16. DTP series contacts are size 12.

4 Communication

4.1 Overview

The IX3212 PDM uses proprietary SAE J1939 CAN messages to configure control, and communicate the I/O status. PowerView displays on a compatible CAN 2.0B CAN bus device can be used to send CAN messages.

Each CAN message has an identifier in the first byte that determines the message context. There are five unique identifiers associated with command and configuration and nine unique identifiers associated with input status, feedback, diagnostics and data reported by the PDM.

4.1.1 Source Address

The Source Address (SA) is set using the first two digital inputs. A 1/open indicates the input is open circuit or at high potential (i.e., connected to battery positive DC). A 0 indicates the input is connected to a low potential (i.e., ground). Inputs contain a pull-up resistor that interprets the input as High if left unconnected. Table 1 lists the available source addresses and allows for up to four PDM modules on a single CAN bus. The PDM defaults to SA 30 (17h) if the inputs are not connected. The PDM does not support SA arbitration according to J1939.

Digital Input 1	Digital Input 2	SA
1/open	1/open	30 (1Eh) default
0	1/open	31 (1Fh)
1/open	0	32 (20h)
0	0	33 (21h)

Table 1 – Source Address Selection

IMPORTANT: When multiple PDMs are connected to the same CAN bus, each PDM must have a unique SA.

The PDM sends messages to and expects to receive messages from SA 17 (11h) regardless of the actual SA claimed by the configuring and controlling device(s). If a system has a cruise control or steer axle controller, the SA may conflict with the PDM.

4.1.2 Loss of Communication

The PDM expects to receive commands from a controlling device every second. If a CAN command message is not received, the PDM assumes that the CAN bus is faulted and goes into a Loss of Communication mode. Each output can be individually configured to respond in prescribed way and is further defined in the section on [Loss of Communication](#).

4.1.3 Output Modes

Two slave modes of operation are possible where the PDM is configured and controlled by a PowerView display or some other CAN bus controller.

1. **High-Side Switch (HSS):** This mode of operation is the typical standard output to turn a load on or off. The individual outputs can switch up to 15 A loads. This mode also supports PWM to drive a load proportionally (open-loop).
2. **H-Bridge (HB):** This mode allows two adjacent outputs to switch polarity of the voltage applied to the load. This is often used to change direction of a DC motor and run it in reverse. This mode supports PWM to drive a load proportionally.

4.1.4 Special Methods of Operation

The PDM is a flexible power I/O module and offers the following configurable features:

4.1.4.1 Power on Reset (POR)

This mechanism enables the PDM to retain an output state through power cycles of the unit. The PDM can power up with individual outputs at predefined PWM levels.

4.1.4.2 Local Source Control

Local Source Control (LSC) is a mode that enables any digital input to trigger the respective output. The effect of this mode is to allow any number of outputs to be autonomously commanded by the specified input.

It is possible to use the PDM in stand-alone operation using LSC. Once the PDM has been configured on the production line, the unit can operate autonomously.

An example use of this function is connecting a key switch to a digital input on the PDM to power an output, which in turn energizes the remainder of the electronic modules that are driven by the key switch.

Using this feature inhibits the other output modes of operation such as the PWM values on the specific outputs configured for LSC mode.

IMPORTANT: Configuring LSC mode on an output disables the Loss of Communication function for the respective output since there is no way of knowing if CAN communication is expected or not.

4.2 Naming and Numbering Conventions

The byte/bit order is represented in the following figure. Bit 1 is the least significant bit (lsb) and Bit 8 is the most significant bit (msb). Byte 1 is the transmitted first and Byte 8 is last (i.e. sequential).

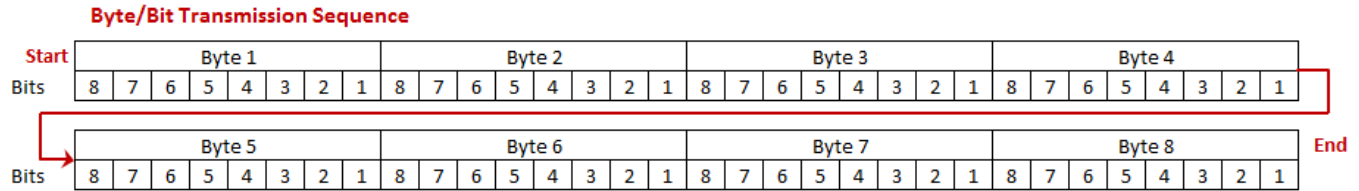

The structures are defined for each type of configuration, control, feedback and diagnostic message.

The following example message structure closely follows the SAE J1939 PGN convention. The message must contain 8 bytes.

Example Message

Data Length 8 bytes

Start Position	Length	Parameter Name	Reference
1	1 byte	Feedback and Diagnostics Identifier	4.5.1.1
2.7	2 bits	Digital Input 4	4.5.1.2
2.5	2 bits	Digital Input 3	4.5.1.2
2.3	2 bits	Digital Input 2	4.5.1.2
2.1	2 bits	Digital Input 1	4.5.1.2
3.7	2 bits	Digital Input 8	4.5.1.2
3.5	2 bits	Digital Input 7	4.5.1.2
3.3	2 bits	Digital Input 6	4.5.1.2
3.1	2 bits	Digital Input 5	4.5.1.2
4.7	2 bits	Digital Input 12	4.5.1.2
4.5	2 bits	Digital Input 11	4.5.1.2
4.3	2 bits	Digital Input 10	4.5.1.2
4.1	2 bits	Digital Input 9	4.5.1.2
5	2 bytes	Analog Input 1	4.5.1.3
7	2 bytes	Analog Input 2	4.5.1.3

Bit placement is sequential from the starting byte/bit position. For example, an analog input is expressed as a 10 bit value in 2 bytes of data. The start position is given as 2.2 meaning byte 2, bit 2. The 10 bits are ordered starting in byte 2, bit 2 and continue throughout byte 1. The illustration below shows the numeric value 221 (DDh) or 00 1101 1101 in binary format in the dark gray portion. The light gray bits are not used.

Example Start Position

	Byte 1								Byte 2								Byte 3								Byte 4							
Bits	8	7	6	5	4	3	2	1	8	7	6	5	4	3	2	1	8	7	6	5	4	3	2	1	8	7	6	5	4	3	2	1
Data	1	1	0	1	1	1	0	1	1	1	1	1	1	1	0	0																

NOTE: As specified by J1939, unused data bits are filled with 1 and report back as 0.

4.3 Configuring

The IX3212 PDM is configured via the CAN bus messages for either slave or LSC (autonomous) operation. In the slave configuration, where a PowerView display or a CAN bus controller is controlling the PDM, it is recommended that the configuration messages be sent on every power-up. It is also possible to re-configure the PDM on the fly.

The following two message types define how to configure the PDM:

- [Configure Output](#)
- [Configure Output Channels](#)

PowerVision Configuration Studio® 2.7 and later versions have a development application which makes it easy to configure and control the Output Functions and Channels using PowerView displays.

See the PowerVision Applications Reference Manual for further details on the use of the application.

4.3.1 Configure Output Function

The Configure Output Function message sets the mode, power-on characteristics and general behavior for each output. The message must be sent at least one time for LSC and as often as required if the output configuration needs to change. A handshake message is returned by the PDM to confirm the setup.

CAN message sent to the PDM to set up the configuration or command the outputs.

Transmission Repetition	On change of state	
Data Length	8 bytes	
Data Page	0	
PDU Format (PF)	239	Proprietary A, PDU1 format
PDU Specific (PS)	30 (1Eh) or as set	DA (Source Address of the PDM)
Priority	5	
Parameter Group Number	61184 (EF00h)	

Start Position	Length	Parameter Name	Reference
1	1 byte	Configuration or Command Identifier	4.3.1.1
2	1 byte	Output Channel Number	4.3.1.2
3	1 byte	Soft-Start Step Size	4.3.1.3
4	1 byte	Motor/Lamp Mode	4.3.1.4
5.3	6 bits	Reserved (Always high, binary 111111)	
5.1	2 bits	Loss of Communication	4.3.1.5
6	1 byte	Reserved (always FFh)	
7.4	5 bits	POR Command	4.3.1.6
7.3	1 bit	POR Enable	4.3.1.7
7.2	1 bit	Command Type	4.3.1.8
7.1	1 bit	Motor Braking	4.3.1.9
8.5	4 bits	LSC Digital Input	4.3.1.10
8.3	2 bits	Calibration Time	4.3.1.11
8.1	2 bits	Response	4.3.1.12

4.3.1.1 Configuration Identifier

This identifier is a secondary address that indicates the type of message, in this case output functionality.

0 Output Configuration

Data Length: 1 byte
Resolution: 5 states / 1 byte 0 offset
Data Range: 0 Operational Range: same as data range
Type: Status (command)
PGN: PGN 61184 – [Configure Output](#)

4.3.1.2 Output Channel

This specifies which output channel, 1-12, is configured by the message.

1 = Channel 1, 2 = Channel 2, 3 = Channel 3, etc.

Data Length: 1 byte
Resolution: 8 states / 1 byte 0 offset
Data Range: 1 to 12 Operational Range: same as data range
Type: Status (command)
PGN: PGN 61184 – [Configure Output](#)

4.3.1.3 Soft-Start Step Size

Motors and lamps often require soft-starting to reduce the in-rush current and prevent the PDM from producing over-current errors. Also lights can be soft-started to reduce the in-rush current and potentially extend the filament life.

1 = 1%, 2 = 2%, 3 = 3%, etc.
255 (FFh) = 100% (Soft-Start disabled)

Data Length: 1 byte
Resolution: 1% / 1 bit 0 offset
Data Range: 1 to 100 Operational Range: same as data range
Type: Status (command)
PGN: PGN 61184 – [Configure Output](#)

Soft-start step size is a PWM value representing a percentage in which the output is increased in steps. Depending on the mode (i.e. lamp or motor) selected, the time between each step varies. The first step lasts 500 ms in either mode. The subsequent steps are only 20 ms in lamp mode. Alternately, the motor mode remains at 500 ms step intervals. Lower percentage soft-start values therefore equate to longer soft-start times.

For example, a soft-start value of 10% using lamp mode means that the PDM reaches 100% after 680 ms. Whereas the same 10% value using motor mode takes 5,000 ms to reach 100%. The illustrations below show the time base of an example 10% PWM value.

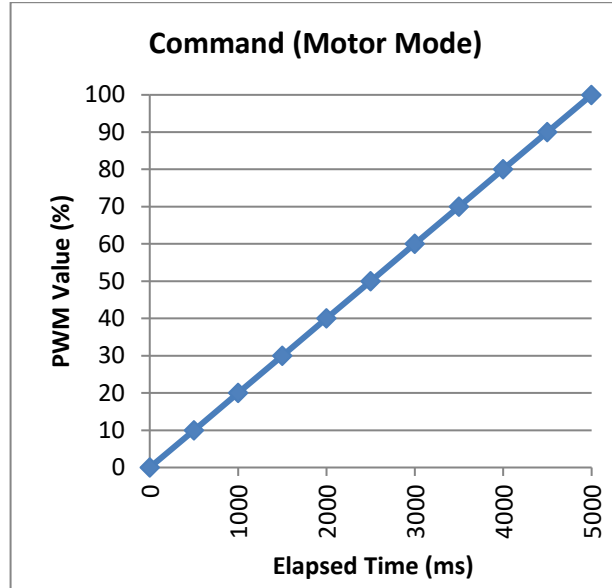
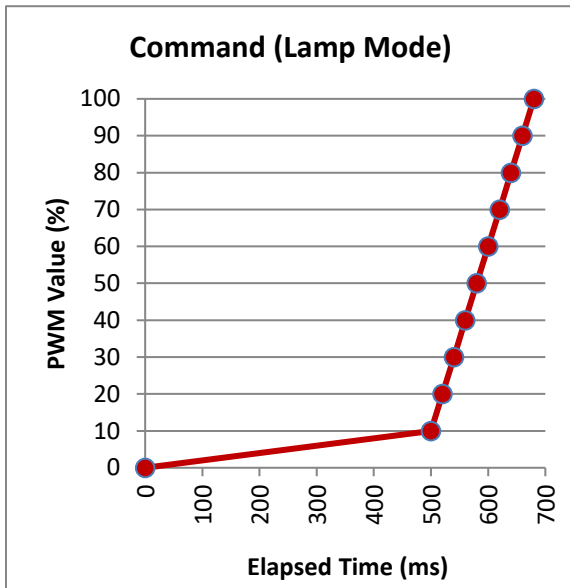

Depending on the Command (final) value and the soft-start step size, the elapsed time to reach the final PWM value may vary by one or two steps.

4.3.1.4 Motor/Lamp Mode

The over-current profile can be selected depending on the type of load. See the current profile in the figures below.

0 Lamp
1 Motor

Data Length: 1 byte
Resolution: 2 states / 1 byte 0 offset
Data Range: 0 to 1 Operational Range: same as data range
Type: Status (command)
PGN: PGN 61184 – [Configure Output](#)

Lamp filaments exhibit a high peak inrush current when first powered. A stair-shaped profile for the overcurrent protection is preprogrammed at the factory.

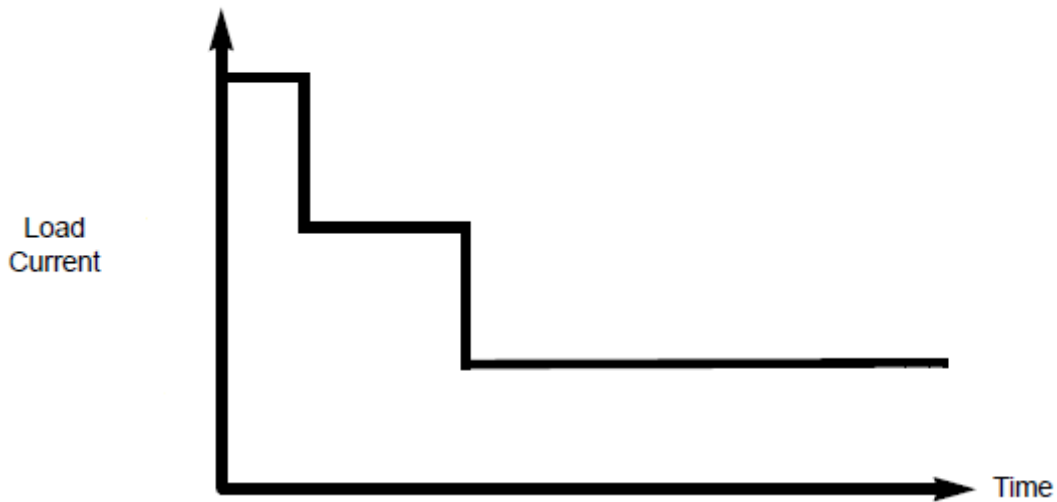

The lamp mode peak current is limited to 110 A nominally for 17.2 ms. The next level is 43.3 A for 137 ms. Finally, up to 15 A of continuous current is the maximum limit. If the limit is exceeded anywhere along the profile including a lower continuous current limit that may be set, the FET goes into protection mode.

DC motors or inductive loads such as relays exhibit a delayed inrush or stall current. A window-shaped profile for the overcurrent and overheating protection is pre-programmed at the factory.

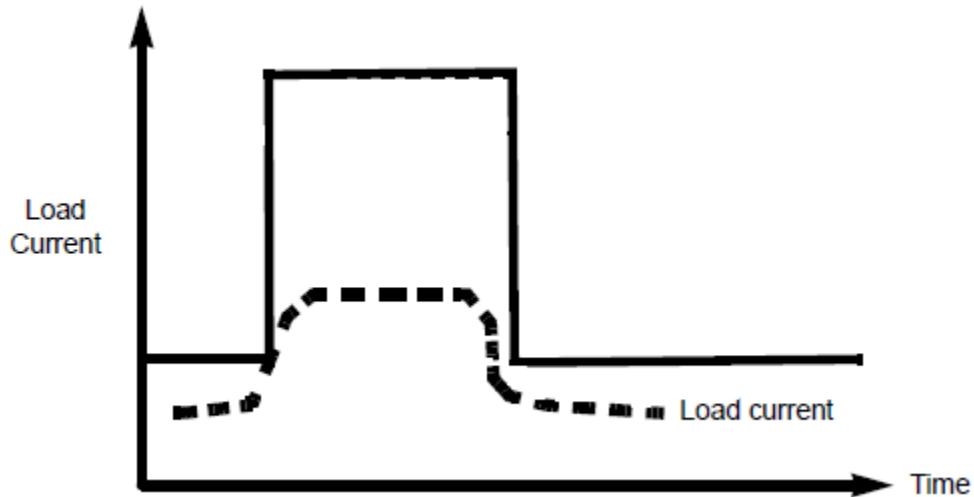

The motor mode peak current is limited to 43.3 A nominally for up to 429 ms. The final level is set at up to 15 A continuous current. If the limit is exceeded anywhere along the profile including a lower continuous current limit that may be set, the FET goes into protection mode.

The Soft-Start function can be used in combination with the motor/lamp mode to affect the inrush current and prevent an over-current condition.

NOTE: The inductance of the motor, inertia of the rotor and load, including a stalled rotor condition factor into whether the PDM is capable of driving a DC motor. Experimentation is often necessary to determine if a DC motor is compatible with the PDM.

4.3.1.5 Loss of Communication

Defines how the outputs behave when CAN communication is lost. This can be useful in many applications, but because the PDM is no longer under supervisory control, appropriate testing should be conducted to ensure safe operation.

- 00 = CH Unchanged (Last Commanded)
- 01 = CH -100% (H-Bridge Only)
- 10 = CH +100%
- 11 = CH 0% (off)

Data Length: 2 bits

Resolution: 4 states / 2 bits 0 offset

Data Range: 0 to 3 Operational Range: same as data range

Type: Status (command)

PGN: PGN 61184 – [Configure Output](#)

4.3.1.6 POR Command

The POR Command sets the percentage PWM level for each output at module power on/reset. This establishes the output PWM level an individual output will be commanded to at start up. This can be useful in many applications, but because the PDM is no longer under supervisory control, appropriate testing should be conducted to ensure safe operation.

- Data Length:** 5 bits, signed
- Resolution:** 6.25 % / lsb -100 % offset
- Data Range:** -100 % to 100 % Operational Range: same as data range
- Type:** Status (command)
- PGN:** PGN 61184 – [Configure Output](#)

POR Command Value	Commanded PWM %	Actual PWM %
01111	93.75	100
01110	87.5	87.5
01101	81.25	81.25
01100	75	75
01011	68.75	68.75
01010	62.5	62.5
01001	56.25	56.25
01000	50	50
00111	43.75	43.75
00110	37.5	37.5
00101	31.25	31.25
00100	25	25
00011	18.75	18.75
00010	12.5	12.5
00001	6.25	6.25
00000	0	0
11111	-6.25	-6.25
11110	-12.5	-12.5
11101	-18.75	-18.75
11100	-25	-25
11011	-31.25	-31.25

POR Command Value	Commanded PWM %	Actual PWM %
11010	-37.5	-37.5
11001	-43.75	-43.75
11000	-50	-50
10111	-56.25	-56.25
10110	-62.5	-62.5
10101	-68.75	-68.75
10100	-75	-75
10011	-81.25	-81.25
10010	-87.5	-87.5
10001	-93.75	-93.75
10000	-100	-100

4.3.1.7 POR Enable

POR enables the above power on reset functionality for the individual output.

1 Disabled
0 Enabled

Data Length: 1 bit
Resolution: 2 states / 1 bit 0 offset
Data Range: 0 to 1 **Operational Range:** same as data range
Type: Status (command)
PGN: PGN 61184 – [Configure Output](#)

4.3.1.8 Command Type

Command type determines if the loss of CAN feature is enabled or disabled.

0 Enabled
1 Disabled

Data Length: 1 bit
Resolution: 2 states / 1 bit 0 offset
Data Range: 0 to 1 **Operational Range:** same as data range
Type: Status (command)
PGN: PGN 61184 – [Configure Output](#)

4.3.1.9 Motor Braking

Motor braking for H-bridge controlled outputs. This enables motor braking for the specific H-Bridge pair.

0 Disabled
1 Enabled

Data Length: 1 bit
Resolution: 2 states / 1 bit 0 offset
Data Range: 0 to 1 Operational Range: same as data range
Type: Status (command)
PGN: PGN 61184 – [Configure Output](#)

4.3.1.10 LSC Digital Input

Specifies the Digital Input number that is associated with the output channel for the LSC mode.

0 Channel 1
1 Channel 2
2 Channel 3
..
11 Channel 12
15 (0xF) LSC disabled (default)

NOTE: When not using LSC, all 4 bits must be 1111 (0x15). The two bytes associated with calibration time below, since it is unsupported, must be 11. The two bits associated with Response below must also be 11. Therefore, when not using LSC, Byte 8 must be 0xFF.

Data Length: 4 bits
Resolution: 12 states / 4 bits 0 offset
Data Range: 0 to 11 Operational Range: same as data range
Type: Status (command)
PGN: PGN 61184 – [Configure Output](#)

4.3.1.11 Calibration Time

Calibration time. This feature is not currently supported.

0 Override Fixed (always 0 for H-bridge)
1 Override Calibration Time

NOTE: Since this feature is unsupported, these two bits must always be 11.

Data Length: 2 bits
Resolution: 2 states / 2 bits 0 offset
Data Range: 0 to 1 Operational Range: same as data range
Type: Status (command)
PGN: PGN 61184 – [Configure Output](#)

4.3.1.12 Response

Response indicates how the output channel turns-on depending on the input is active low, high or both (either low or high).

00 Reserved
01 Active Low
10 Active High
11 Active Low or High

Data Length: 2 bits

Resolution: 2 states / 2 bits 0 offset

Data Range: 0 to 1 Operational Range: same as data range

Type: Status (command)

PGN: PGN 61184 – [Configure Output](#)

4.3.2 Configure Output Channels

The following CAN message also configures the outputs in two groups.

Configure Output Channels is a message sent to the PDM to set up the high-current output channels as a single high-side output or as an H-bridge pair. It also sets the current limit and reset behavior. Depending on the output configuration identifier, the message applies to either output channels 1-6 or 7-12 respectively.

Note: When channels are set to H-bridge pair, they are paired consecutively (i.e. 1 and 2, 3 and 4, etc.).

Transmission Repetition	On change of state (at least one time, < 1 sec)	
Data Length	8 bytes	
Data Page	0	
PDU Format (PF)	239	Proprietary A, PDU1 format
PDU Specific (PS)	30 (1Eh) or as set	DA (Source Address of the PDM)
Priority	5	
Parameter Group Number	61184 (EF00h)	

Start Position	Length	Parameter Name	Reference
1	1 byte	Output Channel Group Identifier	4.3.2.1
2.5	4 bits	Current Limit (Output Channel 1 or 7)	4.3.2.2
2.3	2 bits	Feedback Type (Output Channel 1 or 7)	4.3.2.3
2.2	1 bit	Automatic Reset (Output Channel 1 or 7)	4.3.2.3
2.1	1 bit	High-Side or H-Bridge (Output Channel 1 or 7)	4.3.2.5
3.5	4 bits	Current Limit (Output Channel 2 or 8)	4.3.2.2
3.3	2 bits	Feedback Type (Output Channel 2 or 8)	4.3.2.3
3.2	1 bit	Automatic Reset (Output Channel 2 or 8)	4.3.2.3
3.1	1 bit	High-Side or H-Bridge (Output Channel 2 or 8)	4.3.2.5
4.5	4 bits	Current Limit (Output Channel 3 or 9)	4.3.2.2
4.3	2 bits	Feedback Type (Output Channel 3 or 9)	4.3.2.3
4.2	1 bit	Automatic Reset (Output Channel 3 or 9)	4.3.2.3
4.1	1 bit	High-Side or H-Bridge (Output Channel 3 or 9)	4.3.2.5
5.5	4 bits	Current Limit (Output Channel 4 or 10)	4.3.2.2
5.3	2 bits	Feedback Type (Output Channel 4 or 10)	4.3.2.3
5.2	1 bit	Automatic Reset (Output Channel 4 or 10)	4.3.2.3
5.1	1 bit	High-Side or H-Bridge (Output Channel 4 or 10)	4.3.2.5

6.5	4 bits	Current Limit (Output Channel 5 or 11)	4.3.2.2
6.3	2 bits	Feedback Type (Output Channel 5 or 11)	4.3.2.3
6.2	1 bit	Automatic Reset (Output Channel 5 or 11)	4.3.2.3
6.1	1 bit	High-Side or H-Bridge (Output Channel 5 or 11)	4.3.2.5
7.5	4 bits	Current Limit (Output Channel 6 or 12)	4.3.2.2
7.3	2 bits	Feedback Type (Output Channel 6 or 12)	4.3.2.3
7.2	1 bit	Automatic Reset (Output Channel 6 or 12)	4.3.2.3
7.1	1 bit	High-Side or H-Bridge (Output Channel 6 or 12)	4.3.2.5
8	1 byte	Reserved (FFh)	

4.3.2.1 Output Channel Group Identifier

This identifier is a secondary address that determines which set of outputs will be configured.

6 Output Channels 1-6
7 Output Channels 7-12

Data Length: 1 byte
Resolution: 2 states / 1 byte 0 offset
Data Range: 0 Operational Range: same as data range
Type: Status (command)
PGN: PGN 61184 – [Configure Output Channels](#)

4.3.2.2 Current Limit

Current Limit sets the steady-state, over-current shutdown level in 2.5A increments.

0 – 0.0 A
1 – 2.5 A
2 – 5.0 A
3 – 7.5 A
4 – 10.0 A
5 – 12.5 A
6 – 15.0 A
7-15 Reserved

Data Length: 4 bits
Resolution: 7 states / 4 bits 0 offset
Data Range: 0 – 15 A Operational Range: same as data range
Type: Status (command)
PGN: PGN 61184 – [Configure Output Channels](#)

4.3.2.3 Feedback Type

Feedback type is always set to Current. The other modes are not supported on the IX3212-24.

- 00 Position feedback (not supported on the IX3212-24)
- 01 Rate feedback (not supported on the IX3212-24)
- 10 Power feedback (not supported on the IX3212-24)
- 11 Current feedback (always)

Data Length: 2 bits
Resolution: 4 states / 2 bits 0 offset
Data Range: 3 Operational Range: same as data range
Type: Status (measured)
PGN: PGN 61184 – [Configure Output Channels](#) or [Output Configuration Handshake](#)

4.3.2.4 Automatic Reset

Automatic Reset specifies if the PDM shall autonomously reset the output or remain in the OFF state during an over-current event. Once an output is turned OFF by the PDM, the output needs to be commanded OFF prior to commanding the output.

- 0 Automatic reset (5 attempts to reset before remaining OFF)
- 1 No automatic reset (remain in OFF state)

Data Length: 1 bit
Resolution: states / 1 byte 0 offset
Data Range: 0 Operational Range: same as data range
Type: Status (command)
PGN: PGN 61184 – [Configure Output Channels](#) or [Output Configuration Handshake](#)

4.3.2.5 High-Side or H-Bridge

High-side or H-Bridge configures either a single output for driving discrete loads or assigns a pair of outputs for directional motor control. H-Bridge pairs are grouped as follows: 1 and 2, 3 and 4, 5 and 6, etc.

Note: When configuring the output for H-bridge operation, the second channel in the pair (even number) must have byte 2 set to 255.

0 High-Side (single)
1 H-Bridge (dual)

Data Length: 1 bit

Resolution: 2 states / 1 bit 0 offset

Data Range: 0 **Operational Range:** same as data range

Type: Status (command)

PGN: PGN 61184 – [Configure Output Channels](#)

4.4 Commanding

After the configuration is complete, the IX3212 outputs can be commanded. The following message type defines how to command the PDM:

- [Command Output Channels](#)

4.4.1 Command Output Channels

The command output channels message sets the PWM value of each output channel. The message bytes refer to outputs 1-6 or 7-12, depending on the value of the identifier in the first byte.

NOTE: A Command message must be broadcast to the PDM at least once every second. Otherwise the PDM enters the Loss of Communication state.

CAN message sent to the PDM to drive the outputs.

Transmission Repetition	20 – 500 ms	
Data Length	8 bytes	
Data Page	0	
PDU Format (PF)	239	Proprietary A, PDU1 format
PDU Specific (PS)	30 (1Eh) or as set	DA (Source Address of the PDM)
Priority	5	
Parameter Group Number	61184 (EF00h)	

Start Position	Length	Parameter Name	Reference
1	1 byte	Output Command Identifier	4.4.1.1
2	1 byte	Command (Output Channel 1 or 7)	4.4.1.2
3	1 byte	Command (Output Channel 2 or 8)	4.4.1.2
4	1 byte	Command (Output Channel 3 or 9)	4.4.1.2
5	1 byte	Command (Output Channel 4 or 10)	4.4.1.2
6	1 byte	Command (Output Channel 5 or 11)	4.4.1.2
7	1 byte	Command (Output Channel 6 or 12)	4.4.1.2
8.1	1 bit	Enable (Output Channel 1 or 7)	4.4.1.3
8.2	1 bit	Enable (Output Channel 2 or 8)	4.4.1.3
8.3	1 bit	Enable (Output Channel 3 or 9)	4.4.1.3
8.4	1 bit	Enable (Output Channel 4 or 10)	4.4.1.3
8.5	1 bit	Enable (Output Channel 5 or 11)	4.4.1.3
8.6	1 bit	Enable (Output Channel 6 or 12)	4.4.1.3
8.7	2 bits	Module Transmit Rate / Unused	4.4.1.4

4.4.1.1 Output Command Identifier

This value defines which output channels the Command Output Channels message is referencing.

- 4 Output Channels 1-6
- 5 Output Channels 7-12

Data Length: 1 byte
Resolution: 2 states / 1 byte 0 offset
Data Range: 4 or 5 Operational Range: same as data range
Type: Status (command)
PGN: PGN 61184 – [Command Output Channels](#)

4.4.1.2 Command

This value defines the output channel's PWM value as a percentage.
This is a signed value (msb is the sign bit).

Note: When an output is either disabled or the second channel in an H-bridge pair, the command should be set to 0 for that channel.

- 0 0%
- 1 +0.78125%
- ...
- 127 +100%
- 128 -100%
- ...
- 255 -0.78125%

Data Length: 1 byte
Resolution: 0.78125 % / lsb 0 offset
Data Range: -100% to +100% Operational Range: same as data range
Type: Status (command)
PGN: PGN 61184 – [Command Output Channels](#)

IMPORTANT: It may be necessary to turn on the outputs in a staggered manner when multiple high-currents loads need to be energized due to the high inrush current.

4.4.1.3 Enable

This value defines whether the specified channel is enabled or disabled.

NOTE: When a channel is disabled, it must have byte 2 set to 255 (FFh).

0 Disabled
1 Enabled

Data Length: 1 bit
Resolution: 2 states / 1 bit 0 offset
Data Range: 0 or 1 Operational Range: same as data range
Type: Status (command)
PGN: PGN 61184 – [Command Output Channels](#)

4.4.1.4 Module Transmit Rate

This value defines the repetition rate that the PDM will transmit the feedback and diagnostics.

00 500ms
01 250ms
02 50ms
03 10ms

Data Length: 2 bits
Resolution: 4 states / 2 bits 0 offset
Data Range: 0 to 3 Operational Range: same as data range
Type: Status (command)
PGN: PGN 61184 – [Command Output Channels](#)

4.5 Feedback and Diagnostics

The IX3212 PDM will periodically transmit feedback messages with the measured analog values and handshake.

The following message type defines how to command the PDM:

- [Analog Inputs 1-2, Digital Inputs Feedback](#)
- [Analog Inputs 3-4, Output Diagnostics](#)
- [Analog Inputs 5-6, Battery and Sensor Supply](#)
- [Analog Inputs 7-8, Software Version and Power Supply](#)
- [Output Feedback](#)
- [Output Function Handshake](#)
- [Output Configuration Handshake](#)

4.5.1 Analog Inputs 1-2, Digital Inputs Feedback

The analog channel feedback is the value of the input signal on the respective channel with 10 bit resolution. The digital input indicates if the input is open (floating), connected to ground or the battery.

CAN message sent by the PDM to communicate the measured values.

Transmission Repetition	50 ms minimum (5x the base rate)	
Data Length	8 bytes	
Data Page	0	
PDU Format (PF)	239	Proprietary A, PDU1 format
PDU Specific (PS)	17 (11h)	DA (Source Address of the configuring display or controller)
Priority	5	
Parameter Group Number	61184 (EF00h)	

Start Position	Length	Parameter Name	Reference
1	1 byte	Feedback and Diagnostics Identifier	4.5.1.1
2.7	2 bits	Digital Input 4	4.5.1.2
2.5	2 bits	Digital Input 3	4.5.1.2
2.3	2 bits	Digital Input 2	4.5.1.2
2.1	2 bits	Digital Input 1	4.5.1.2
3.7	2 bits	Digital Input 8	4.5.1.2
3.5	2 bits	Digital Input 7	4.5.1.2
3.3	2 bits	Digital Input 6	4.5.1.2
3.1	2 bits	Digital Input 5	4.5.1.2
4.7	2 bits	Digital Input 12	4.5.1.2
4.5	2 bits	Digital Input 11	4.5.1.2
4.3	2 bits	Digital Input 10	4.5.1.2
4.1	2 bits	Digital Input 9	4.5.1.2
5	2 bytes	Analog Input 1	4.5.1.3
7	2 bytes	Analog Input 2	4.5.1.3

Regardless of the Source Address of the configuring and controlling device, that device must listen for feedback messages addressed to Source Address 17 (11h).

4.5.1.1 Feedback and Diagnostics Identifier

All feedback and diagnostic messages contain a unique identifier which determines the associated information.

- 128 (80h) Analog Inputs 1-2, Digital Inputs
- 129 (81h) Analog Inputs 3-4, Output Diagnostics
- 130 (82h) Analog Inputs 5-6, Battery and Sensor Supply
- 131 (83h) Analog Inputs 7-8, Miscellaneous Feedback
- 132 (84h) Outputs 1-6 Feedback
- 133 (85h) Outputs 7-12 Feedback
- 134 (86h) Motor Model Handshake
- 135 (87h) Output Configuration Handshake Channels 1-6
- 136 (88h) Output Configuration Handshake Channels 7-12

Data Length: 1 byte
Resolution: 1 state / 1 byte 0 offset
Data Range: 0 Operational Range: same as data range
Type: Status (command)
PGN: PGN 61184 – [Feedback and Diagnostics](#)

4.5.1.2 Digital Inputs

Three states describe each digital input.

- 00 Open Circuit
- 01 Short-to-ground
- 10 Short-to-battery
- 11 Not Available

Data Length: 2 bits
Resolution: 3 states / 2 bits 0 offset
Data Range: - Operational Range: same as data range
Type: Status (measured)
PGN: PGN 61184 – [Feedback and Diagnostics](#)

4.5.1.3 Analog Inputs

Each analog input is represented by a 10-bit raw value for the 0-5V range by using two bytes.

LSB (8 bits)
MSB (2 bits)

Data Length: 2 bytes

Resolution: 10 bits 0 offset

Data Range: 0-1023 Operational Range: same as data range

Type: Status (command)

PGN: PGN 61184 – [Feedback and Diagnostics](#)

Example: If we consider the 10 bits of Analog Input 1 where 9 is the most significant bit and 0 is the least significant bit with n representing the unused bits, the bytes are ordered as follows:

LSB (byte 5): 76543210

MSB (byte 6): nnnnnn98

See the Condensed Message Definition at the end of the manual for a representation of all analog inputs.

4.5.2 Analog Inputs 3-4, Output Diagnostics

The analog channel feedback is the value of the associated analog inputs. The analog input is represented by a 10 bit raw value for the 0-5 V range. The output diagnostics indicate: no fault, a short-circuit, an over-current condition or an open-circuit.

CAN message sent by the PDM to communicate the measured values of Analog Inputs 3 and 4 as well as the Output diagnostics.

Transmission Repetition	20 – 500 ms	
Data Length	8 bytes	
Data Page	0	
PDU Format (PF)	239	Proprietary A, PDU1 format
PDU Specific (PS)	17 (11h)	DA (Source Address of the configuring display or controller)
Priority	5	
Parameter Group Number	61184 (EF00h) - Feedback and Diagnostics	

Start Position	Length	Parameter Name	Reference
1	1 byte	Feedback and Diagnostics Identifier	4.5.1.1
2.7	2 bits	Output 1 Diagnostic	4.5.2.1
2.5	2 bits	Output 2 Diagnostic	4.5.2.1
2.3	2 bits	Output 3 Diagnostic	4.5.2.1
2.1	2 bits	Output 4 Diagnostic	4.5.2.1
3.7	2 bits	Output 5 Diagnostic	4.5.2.1
3.5	2 bits	Output 6 Diagnostic	4.5.2.1
3.3	2 bits	Output 7 Diagnostic	4.5.2.1
3.1	2 bits	Output 8 Diagnostic	4.5.2.1
4.7	2 bits	Output 9 Diagnostic	4.5.2.1
4.5	2 bits	Output 10 Diagnostic	4.5.2.1
4.3	2 bits	Output 11 Diagnostic	4.5.2.1
4.1	2 bits	Output 12 Diagnostic	4.5.2.1
5	2 bytes	Analog Input 3	4.5.1.3
7	2 bytes	Analog Input 4	4.5.1.3

4.5.2.1 Output Diagnostic

Output channel diagnostic status.

00 No faults
01 Short-circuit
10 Over-current
11 Open-circuit

Data Length: 2 bits

Resolution: 4 states / 2 bits 0 offset

Data Range: 0-3 Operational Range: same as data range

Type: Status (measured)

PGN: PGN 61184 – [Feedback and Diagnostics](#)

4.5.3 Analog Inputs 5-6, Battery and Sensor Supply

The analog channel feedback is as follows: The analog input is represented by a 10 bit raw value for the 0-5 V range. The Sensor supply bits indicate the supply is OK when the bit is high (1). The battery voltage indicates the measured voltage 16 bits reflecting 0-63.99 Volts.

CAN message sent by the PDM to communicate the measured values.

Transmission Repetition	20 – 500 ms	
Data Length	8 bytes	
Data Page	0	
PDU Format (PF)	239	Proprietary A, PDU1 format
PDU Specific (PS)	17 (11h)	DA (Source Address of the configuring display or controller)
Priority	5	
Parameter Group Number	61184 (EF00h) - Feedback and Diagnostics	

Start Position	Length	Parameter Name	Reference
1	1 byte	Feedback and Diagnostics Identifier	4.5.1.1
2.1	1 bit	Sensor Supply Low	4.5.3.1
2.2	1 bit	Sensor Supply High	4.5.3.2 below
2.3-8	6 bits	Reserved (always 3Fh (63))	
3	2 bytes	Battery Voltage	4.5.3.3
5	2 bytes	Analog Input 5	4.5.1.3
7	2 bytes	Analog Input 6	4.5.1.3

4.5.3.1 Sensor Supply Low

5V sensor supply is out of range low.

0 5V output too low
1 5V output OK

Data Length: 1 bit
Resolution: 1 0 offset
Data Range: 0-1 Operational Range: same as data range
Type: Status
PGN: PGN 61184 – [Feedback and Diagnostics](#)

4.5.3.2 Sensor Supply High

5V sensor supply is out of range high.

0 5V output too high
1 5V output OK

Data Length: 1 bit
Resolution: 1 0 offset
Data Range: 0-1 Operational Range: same as data range
Type: Status
PGN: PGN 61184 – [Feedback and Diagnostics](#)

4.5.3.3 Battery Voltage

The measured value of the battery voltage.

Data Length: 2 bytes
Resolution: 10 bits 0 offset
Data Range: 0-63.999 V Operational Range: same as data range
Type: Status (measured)
PGN: PGN 61184 – [Feedback and Diagnostics](#)

4.5.4 Analog Inputs 7-8, Software Version and Power Supply

CAN message sent by the PDM to communicate the measured values.

Transmission Repetition	20 – 500 ms	
Data Length	8 bytes	
Data Page	0	
PDU Format (PF)	239	Proprietary A, PDU1 format
PDU Specific (PS)	17 (11h)	DA (Source Address of the configuring display or controller)
Priority	5	
Parameter Group Number	61184 (EF00h) - Feedback and Diagnostics	

Start Position	Length	Parameter Name	Reference
1	1 byte	Feedback and Diagnostics Identifier	4.5.1.1
2.1	1 bit	Total Current Status	4.5.4.1
2.2	1 bit	Power Supply Status	4.5.4.2
3	2 bytes	Software Version	4.5.4.3
5	2 bytes	Analog Input 7	4.5.1.3
7	2 bytes	Analog Input 8	4.5.1.3

4.5.4.1 Total Current Status

Total current status.

- 0 Total current too high
- 1 Total current OK

Data Length: 1 bit
Resolution: 1 0 offset
Data Range: 0-1 Operational Range: same as data range
Type: Status
PGN: PGN 61184 – [Feedback and Diagnostics](#)

4.5.4.2 Power Supply Status

Power supply status.

- 0 Power supply NOT OK
- 1 Power supply OK

Data Length: 1 bit
Resolution: 1 0 offset
Data Range: 0-1 Operational Range: same as data range
Type: Status
PGN: PGN 61184 – [Feedback and Diagnostics](#)

4.5.4.3 Software Version

The software version number is represented by a 16 bit value.

Data Length: 2 bytes
Resolution: - 0 offset
Data Range: - Operational Range: same as data range
Type: Status (measured)
PGN: PGN 61184 – [Feedback and Diagnostics](#)

4.5.5 Output Feedback

WARNING: Closed-loop proportional control is not recommended due to the non-deterministic nature of the CAN bus.

CAN message sent by the PDM to communicate the measured values of the digital outputs channels.

Transmission Repetition	20 – 500 ms	
Data Length	8 bytes	
Data Page	0	
PDU Format (PF)	239	Proprietary A, PDU1 format
PDU Specific (PS)	17 (11h)	DA (Source Address of the configuring display or controller)
Priority	5	
Parameter Group Number	61184 (EF00h) - Feedback and Diagnostics	

Start Position	Length	Parameter Name	Reference
1	1 byte	Feedback and Diagnostics Identifier (132 or 133)	4.5.1.1
2	1 byte	Output 1 or 7 Feedback	4.5.5.1
3	1 byte	Output 2 or 8 Feedback	4.5.5.1
4	1 byte	Output 3 or 9 Feedback	4.5.5.1
5	1 byte	Output 4 or 10 Feedback	4.5.5.1
6	1 byte	Output 5 or 11 Feedback	4.5.5.1
7	1 byte	Output 6 or 12 Feedback	4.5.5.1
8	1 byte	Unused (always FFh)	

4.5.5.1 Current, Power, Position or Rate Feedback

Note: Only current feedback is supported.

Current Feedback, resolution of 0.125 A / lsb

Power Feedback, 1 W / LSB

Position Feedback, 1% / LSB, offset 75%, range -75 to 180%

Rate Feedback, .25 % / sec / LSB, range 0 to 63.75%

Data Length: 1 byte

Resolution: 1 byte 0 offset

Data Range: 0-15 A Operational Range: same as data range

Type: Status (measured)

PGN: PGN 61184 – [Feedback and Diagnostics](#)

4.5.6 Output Function Handshake

The handshake message is sent back every time a configuration message is received as an acknowledgement of the output channel setup. The handshake message is also sent once per second thereafter for a means of checking the output configuration.

CAN message sent by the PDM to communicate the output channel number, soft-start parameters, motor/lamp mode, loss of communication and other output controls.

Transmission Repetition	On receipt of configuration message or 1,000 ms	
Data Length	8 bytes	
Data Page	0	
PDU Format (PF)	239	Proprietary A, PDU1 format
PDU Specific (PS)	17 (11h)	DA (Source Address of the configuring display or controller)
Priority	5	
Parameter Group Number	61184 (EF00h) - Feedback and Diagnostics	

Start Position	Length	Parameter Name	Reference
1	1 byte	Feedback and Diagnostics Identifier	4.5.1.1
2	1 byte	Channel Number	4.3.1.2
3	1 byte	Soft-Start Step Size	4.3.1.3
4	1 byte	Motor/Lamp Mode	4.3.1.4
5	1 byte	Loss of Communication	4.3.1.5
6	1 byte	Reserved (always FFh)	
7.4	5 bits	Power On Reset Command	4.3.1.6
7.3	1 bit	Power On Reset Enable	4.3.1.7
7.2	1 bit	Command Type	4.3.1.8
7.1	1 bit	Motor Braking	4.3.1.9
8.5	4 bits	Digital Input	4.3.1.10
8.3	2 bits	Calibration Time	4.3.1.11
8.1	2 bits	Response	4.3.1.12

4.5.7 Output Configuration Handshake

After the output channels settings are sent to the PDM, the stored settings are then broadcast back to the configuring device in order to verify the intended configuration. Only after the settings are in agreement should the output be enabled.

CAUTION: Use this message to verify the output settings prior to enabling any output.

This CAN message is broadcast by the PDM to communicate the settings of a group of output channels. Depending on the Feedback and Diagnostics Identifier byte, the message pertains to Output Channels 1-6 or 7-12 respectively.

Transmission Repetition	20 – 500 ms	
Data Length	8 bytes	
Data Page	0	
PDU Format (PF)	239	Proprietary A, PDU1 format
PDU Specific (PS)	17 (11h)	DA (Source Address of the configuring display or controller)
Priority	5	
Parameter Group Number	61184 (EF00h) - Feedback and Diagnostics	

Start Position	Length	Parameter Name	Reference
1	1 byte	Feedback and Diagnostics Identifier (135 or 136)	4.5.1.1
2.5	4 bits	Current Limit (Output Channel 1 or 7)	4.3.2.2
2.3	2 bits	Feedback Type (Output Channel 1 or 7)	4.3.2.3
2.2	1 bit	Automatic Reset (Output Channel 1 or 7)	4.3.2.3
2.1	1 bit	High-Side or H-Bridge (Output Channel 1 or 7)	4.3.2.5
3.5	4 bits	Current Limit (Output Channel 2 or 8)	4.3.2.2
3.3	2 bits	Feedback Type (Output Channel 2 or 8)	4.3.2.3
3.2	1 bit	Automatic Reset (Output Channel 2 or 8)	4.3.2.3
3.1	1 bit	High-Side or H-Bridge (Output Channel 2 or 8)	4.3.2.5
4.5	4 bits	Current Limit (Output Channel 3 or 9)	4.3.2.2
4.3	2 bits	Feedback Type (Output Channel 3 or 9)	4.3.2.3
4.2	1 bit	Automatic Reset (Output Channel 3 or 9)	4.3.2.3
4.1	1 bit	High-Side or H-Bridge (Output Channel 3 or 9)	4.3.2.5
5.5	4 bits	Current Limit (Output Channel 4 or 10)	4.3.2.2
5.3	2 bits	Feedback Type (Output Channel 4 or 10)	4.3.2.3

This CAN message is broadcast by the PDM to communicate the settings of a group of output channels. Depending on the Feedback and Diagnostics Identifier byte, the message pertains to Output Channels 1-6 or 7-12 respectively.

Transmission Repetition	20 – 500 ms	
Data Length	8 bytes	
Data Page	0	
PDU Format (PF)	239	Proprietary A, PDU1 format
PDU Specific (PS)	17 (11h)	DA (Source Address of the configuring display or controller)
Priority	5	
Parameter Group Number	61184 (EF00h) - Feedback and Diagnostics	

Start Position	Length	Parameter Name	Reference
5.2	1 bit	Automatic Reset (Output Channel 4 or 10)	4.3.2.3
5.1	1 bit	High-Side or H-Bridge (Output Channel 4 or 10)	4.3.2.5
6.5	4 bits	Current Limit (Output Channel 5 or 11)	4.3.2.2
6.3	2 bits	Feedback Type (Output Channel 5 or 11)	4.3.2.3
6.2	1 bit	Automatic Reset (Output Channel 5 or 11)	4.3.2.3
6.1	1 bit	High-Side or H-Bridge (Output Channel 5 or 11)	4.3.2.5
7.5	4 bits	Current Limit (Output Channel 6 or 12)	4.3.2.2
7.3	2 bits	Feedback Type (Output Channel 6 or 12)	4.3.2.3
7.2	1 bit	Automatic Reset (Output Channel 6 or 12)	4.3.2.3
7.1	1 bit	High-Side or H-Bridge (Output Channel 6 or 12)	4.3.2.5
8	1 byte	Reserved (always FFh)	

4.6 Example Messages

4.6.1 Arbitration Field

The IX3212 PDM follows SAE J1939-21, which defines proprietary Parameter Group Numbers (PGNs). The Protocol Data Unit (PDU) is the bit arbitration field of every message on the CAN bus.

The first three bits are the Priority (P) of the message. The recommended value is 5h (5). When combined with the Reserved (R) bit and Data Page (DP) bit, the value becomes 14h (20).

NOTE: Your application may require adjusting the priority based on other devices on the CAN bus.

The PDU1 format is followed, and the PDU Format (PF) is always set to EFh (239), which is reserved for proprietary use.

The PowerView display or CAN bus controller send messages to the PDM at Destination Address 1Eh (30), which is the same as the PDM Source Address.

The PDM broadcasts messages to Destination Address 11h (17) regardless of the actual Source Address of the PowerView display or CAN bus controller.

The resulting arbitration headers of the messages sent to and from the PDM would look like the following.

J1939 29 bit Identifier (Arbitration Field)

J1939 Frame Format	SOF	ID (11 bits)											SRR	IDE	ID Extension (18 bits)																RTR	RTR		
		Priority			R	DP	PDU Format					PF			DA						SA													
Frame Bit Position	1	2	3	4	5	6	7	8	9	10	11	12	13	14	15	16	17	18	19	20	21	22	23	24	25	26	27	28	29	30	31	32	33	
29 Bit ID Position		28	27	26	25	24	23	22	21	20	19	18		17	16	15	14	13	12	11	10	9	8	7	6	5	4	3	2	1	0			
Message Sent to PDM		14h					EFh (239)						1Eh (30)							11h (17)														
Message Sent from PDM		14h					EFh (239)						11h (17)							1Eh (30)														
		1	0	1	0	0	0	1	1	1	1	1	1	1	1	1	0	0	0	1	1	1	1	0	0	0	0	1	1	1	1	0		
		1	0	1	0	0	0	1	1	1	1	1	1	1	1	1	0	0	0	1	0	0	0	1	0	0	0	1	1	1	1	0		

The eight data bytes from the various PGNs follow the respective header.

4.7 Example Pseudo Code

These are example program flows to configure, command and read the feedback messages.

4.7.1 Configure and Verify Outputs

The following pseudo code outlines the possible steps to take in configuring the PDM:

```
FOR Outputs 1-12
    CONFIGURE Output n function
    READ Output n function handshake
    VERIFY Output n function
ENDFOR

FOR Output Groups 1-6 and 7-12
    CONFIGURE Output Group
    READ Output Config Handshake Message
ENDFOR
```

4.7.2 Command Outputs

The following pseudo code outlines the possible steps to command the PDM:

```
SEQUENCE
    COMMAND Outputs 1-6
    COMMAND Outputs 7-12

    READ AI 1-2 and DIs
    READ AI 3-4 and Output Diagnostics
    READ AI 5-6 and Supplies
    READ AI 7-8
    READ Outputs 1-6 Feedback
    READ Outputs 7-12 Feedback

    IF Error
        Take Action
    ENDIF
```

4.7.3 Read Diagnostics

```
SEQUENCE
    READ AI 1-2 and DIs
    READ AI 3-4 and Output Diagnostics
    READ AI 5-6 and Supplies
    READ AI 7-8
```

5 Troubleshooting

5.1 Output Does Not Respond

Check the battery or power supply connection.

Check the power supply rating.

- The PDM switches a high amount of current. Many power supplies are incapable of sourcing adequate current. Using a battery is the preferred method for powering the PDM.

Check the CAN bus and messaging.

5.2 PDM Does Not Function

Check the battery or power supply connection.

Check the external circuit breaker or fuse.

Check the power supply connection to the PDM.

- Verify by connecting a voltmeter to the 5V Sensor Supply and determine if the unit has power. If the Sensor Supply is not providing 5V, continue to next step.

PDM has been damaged.

- If the PDM is subjected to an extreme over-current event and has no response, replace the unit.

6 Specifications

Operating Voltage:

12V/24V nominal (8-32 V)

Reverse polarity protection

Operating Current:

Total: 70 A, simultaneous active outputs

Standby (idle) current draw: <125 mA typical

Sleep current draw: < 4mA typical

Inputs:

Digital:

12 digital tri-state (high-side, low-side, open)

Input impedance: 7.7 k Ω

	12V System		24V System	
	ON _{min}	ON _{max}	ON _{min}	ON _{max}
High-Side	8.625 V		17.25V	
Low-Side		2.64 V		5.28 V

Analog:

2 analog (resistive), input impedance 2.2 k Ω pull-up

6 analog (0 - 5 VDC), input impedance 100 k Ω pull-down

10 bit resolution

Outputs:

12 Digital High current (15 A maximum each, 70 A total)

Configurable as high-side switch, open-loop PWM or up to 6 H-bridge pairs

PWM frequency: 500 Hz (Outputs 1-6) and 100 Hz (Outputs 7-12)

Maximum off state leakage current: <0.1 mA

Open Load Detection

0.2 A minimum, 0.5 A typical

Sensor Supply: 5 VDC at 70 mA

CAN Interface: CAN 2.0B Active, SAE J1939 Proprietary A messaging, 250 kbps

Housing: PBT cover with E-coated cast aluminum base

Dimensions: 245 mm (L) x 140 mm (W) x 50 mm (H)

Weight: 2 lbs (900 gram)

Connectors: Nickel-plated copper alloy contact surface

Deutsch DT series 12 pin (J3, J4, and J5);

Deutsch DTP series 2 pin (J6);
Deutsch DT HD power series 1 pin (J1 and J2).

Environmental:

Operating Temperature: -40°C to +85°C (-40°F to +185°F)

Storage Temperature: -40°C to +135°C (-40°F to +275°F)

Environmental Sealing: IP 66 and 67

Shock: 30 G, 3 cycles

Vibration: 5 – 25 G, 50 – 2000 Hz, 72 hrs/axis

Immunity:

EN 60945 (ESD immunity, ±6 kV contact and ±8 kV air)

EN 61326-1 (radiated immunity, 10 V/m from 80 MHz to 2.7 GHz)

EN 61326-1 (conducted immunity, fast transients)

EN 61326-1 (conducted immunity, surges on power lines)

EN 60945 (conducted immunity, RF disturbance)

EN 61326-1 (magnetic immunity)

SAE J1113-25 (tri-plate, 10 kHz to 200 MHz L3 (200 V/m) and 200 MHz to 1 GHz L2 (100 V/m))

Emissions:

EN 60945 (conducted, 10 kHz to 30 MHz)

EN 60945 Sec. 9.3 / CISPR 11 Class B (radiated, 150 kHz to 2 GHz)

7 Condensed Message Definition

PDM Receive Messages	Byte 1	Byte 2	Byte 3	Byte 4	Byte 5	Byte 6	Byte 7	Byte 8
Configure Output Function	0	Output Channel	Soft-Start Step Size	Motor/Lamp Mode	Loss of Comm	FF	POR, Cmd, Braking	LSC, Response
Configure Outputs 1-6	6	Output 1 Config	Output 2 Config	Output 3 Config	Output 4 Config	Output 5 Config	Output 6 Config	FF
Configure Outputs 7-12	7	Output 7 Config	Output 8 Config	Output 9 Config	Output 10 Config	Output 11 Config	Output 12 Config	FF
Command Outputs 1-6	4	Output 1 Command	Output 2 Command	Output 3 Command	Output 4 Command	Output 5 Command	Output 6 Command	Outputs 1-6 Enable
Command Outputs 7-12	5	Output 7 Command	Output 8 Command	Output 9 Command	Output 10 Command	Output 11 Command	Output 12 Command	Outputs 7-12 Enable
PDM Transmit Messages	Byte 1	Byte 2	Byte 3	Byte 4	Byte 5	Byte 6	Byte 7	Byte 8
Analog Inputs 1-2, Digital Inputs	128	Digital Inputs 1-4	Digital Inputs 5-8	Digital Inputs 9-12	Analog Input 1 LSB	Analog Input 1 MSB	Analog Input 2 LSB	Analog Input 2 MSB
Analog Inputs 3-4, Output Diagnostics	129	Outputs 1-4 Diagnostics	Outputs 5-8 Diagnostics	Outputs 9-12 Diagnostics	Analog Input 3 LSB	Analog Input 3 MSB	Analog Input 4 LSB	Analog Input 4 MSB
Analog Inputs 5-6, Battery and Sensor Supply	130	Sensor Supply Status	Battery Voltage LSB	Battery Voltage MSB	Analog Input 5 LSB	Analog Input 5 MSB	Analog Input 6 LSB	Analog Input 6 MSB
Analog Inputs 7-8, SW Version, Power Supply	131	Power Supply Status	Software Rev LSB	Software Rev MSB	Analog Input 7 LSB	Analog Input 7 MSB	Analog Input 8 LSB	Analog Input 8 MSB
Outputs 1-6 Feedback	132	Output 1 Feedback	Output 2 Feedback	Output 3 Feedback	Output 4 Feedback	Output 5 Feedback	Output 6 Feedback	FF
Outputs 7-12 Feedback	133	Output 7 Feedback	Output 8 Feedback	Output 9 Feedback	Output 10 Feedback	Output 11 Feedback	Output 12 Feedback	FF
Output Function Handshake	134	Output Channel	Soft-Start Step Size	Motor/Bulb Mode	Loss of CAN	Not Used	POR, Cmd, Braking	LSC, Response
Outputs 1-6 Config Handshake	135	Output 1 Config	Output 2 Config	Output 3 Config	Output 4 Config	Output 5 Config	Output 6 Config	FF
Outputs 7-12 Config Handshake	136	Output 7 Config	Output 8 Config	Output 9 Config	Output 10 Config	Output 11 Config	Output 12 Config	FF

Byte Name	Bit 8	Bit 7	Bit 6	Bit 5	Bit 4	Bit 3	Bit 2	Bit 1	
POR, Command, Braking	POR Command					POR Enable		Command Type	Motor Braking
LSC, Response	LSC Digital Input #				Calibration Time		Response		
Outputs 1-6 Enable	PDM Transmit Rate		Output 6 Enable	Output 5 Enable	Output 4 Enable	Output 3 Enable	Output 2 Enable	Output 1 Enable	
Outputs 7-12 Enable	Reserved (Always 11)		Output 12 Enable	Output 11 Enable	Output 10 Enable	Output 9 Enable	Output 8 Enable	Output 7 Enable	
Configuration CH X	Current Limit				Feedback Type		Automatic Reset	HS or H-Bridge	
Digital Inputs 1-4	Digital Input 4		Digital Input 3		Digital Input 2		Digital Input 1		
Digital Inputs 5-8	Digital Input 8		Digital Input 7		Digital Input 6		Digital Input 5		
Digital Inputs 9-12	Digital Input 12		Digital Input 11		Digital Input 10		Digital Input 9		
Diagnostic CH 1-4	Diagnostic Bits CH 1		Diagnostic Bits CH 2		Diagnostic Bits CH 3		Diagnostic Bits CH 4		
Diagnostic CH 5-8	Diagnostic Bits CH 5		Diagnostic Bits CH 6		Diagnostic Bits CH 7		Diagnostic Bits CH 8		
Diagnostic CH 9-12	Diagnostic Bits CH 9		Diagnostic Bits CH 10		Diagnostic Bits CH 11		Diagnostic Bits CH 12		
Sensor Supply Status	Reserved (Always 111111)					Sensor Supply High		Sensor Supply Low	
Power Supply Status	Reserved (Always 111111)					Power Supply Status		Total Current Status	

In order to consistently bring you the highest quality, full-featured products, we reserve the right to change our specifications and designs at any time. MURPHY products and the Murphy logo are registered and/or common law trademarks of Enovation Controls, LLC. This document, including textual matter and illustrations, is copyright protected by Enovation Controls, LLC, with all rights reserved. (c) 2018 Enovation Controls, LLC. A copy of the warranty may be viewed or printed by going to www.enovationcontrols.com/warranty

ENOVATION CONTROLS CORPORATE HEADQUARTERS

5311 S 122ND EAST AVENUE
TULSA, OK 74146

ENOVATION CONTROLS LTD. – UNITED KINGDOM

CHURCH ROAD LAVERSTOCK
SALISBURY SP1 1QZ UK

SUN MURPHY INTERNATIONAL TRADING (SHANGHAI) CO., LTD

815 ROOM, 6# BUILDING, 351 SIZHUAN ROAD
SONGJIANG DISTRICT, SHANGHAI 201601, CHINA

ENOVATION CONTROLS INDIA PVT. LTD.

301, 3RD FLOOR, KRSNA CHAMBERS,
11 GALAXY GARDENS, NORTH MAIN ROAD,
KOREGAON PARK, PUNE 411001,
MAHARASHTRA, INDIA

U.S. SALES & SUPPORT

PHONE: 918 317 4100
EMAIL: SALES@ENOVATIONCONTROLS.COM
WWW.ENOVATIONCONTROLS.COM

MURPHY INDUSTRIAL PANEL DIVISION

PHONE: 918 317 4100
EMAIL: IPDSALES@ENOVATIONCONTROLS.COM

INTERNATIONAL SALES & SUPPORT

EUROPE, MIDDLE EAST, AFRICA

PHONE: +44 1722 410055
EMAIL: SALES@ENOVATIONCONTROLS.EU

CHINA

PHONE: +86 21 6237 5885
EMAIL: APSALES@ENOVATIONCONTROLS.COM

INDIA

PHONE: +91 91581 37633
EMAIL: INDIASALES@ENOVATIONCONTROLS.COM



FM 28221 (Tulsa, OK - USA)
FM 28422 (UK)